

Article number: 6160401210

Description: Welding hub for taper bush type MSB
for taper bush 1210

Measures

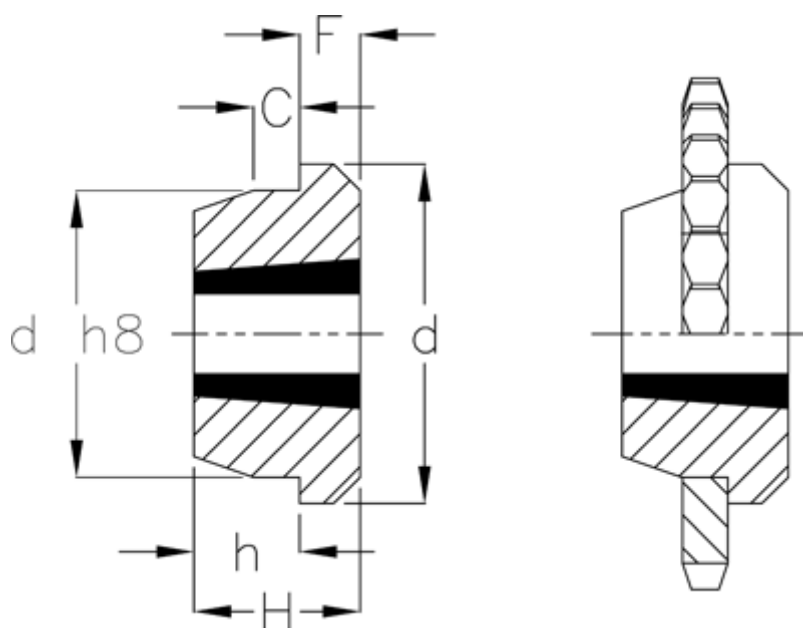

C	= 10
d	= 73
d H8	= 60
F	= 9
For taper bush = 1210	
H	= 25
h	= 16